



Introduction

The rich variety of subjects and methods developed at ISOLDE was nicely demonstrated over the past year through numerous letter publications. The puzzle of the island of inversion, discovered at CERN three decades ago, was finally completed through the observation of the second $J^\pi=0^+$ state in ^{32}Mg in a (t.p) reaction performed with MINIBALL and TREX. Mass measurements of extremely n-rich Kr isotopes were interpreted for the first time in the framework of quantum phase transitions. The measurement of elastic scattering of ^{11}Be will become a textbook example of the influence of a neutron halo on the nuclear rainbow. Laser spectroscopy is in full bloom, revealing deformation and structural changes throughout the nuclear chart. Possibly the most publicized ISOLDE result was the unexpected observation of asymmetric fission of ^{180}Hg which made headlines both inside and outside of CERN. In solid state physics a recent experiment has revealed that the room temperature magnetic behaviour, observed in semiconductors such as ZnO, is caused by paramagnetism rather than the ordered ferromagnetism, a result with consequences for potential spintronic materials. If you want to catch up on all this and more a complete ISOLDE publication list is now available on our website: <http://isolde.web.cern.ch/ISOLDE/science/SOLDE%20Publications%202010%20v1.php> The 2010 running period was also very fruitful, as demonstrated by the reports in this newsletter, exploiting the unique variety of beams available throughout the nuclear chart. Neutron rich Be isotopes continued to fascinate, with transfer reactions induced by ^{11}Be and laser spectroscopy of ^{12}Be benefitting from world record intensities. Transfer reactions using a tritium target, unique to ISOLDE, are expected to yield

new information on the N=28 shell closure. The yields and variety of very heavy nuclei continued to be improved with the first successful extraction of n-rich Au isotopes and new measurements of beta-delayed fission of ^{178}Tl and ^{202}Fr and Coulomb excitation of ^{224}Ra . On the applied front, biophysics investigations are continuously increasing in importance, in particular through studies of the role of metal ions in biological systems. All these accomplishments are made possible by the continued R&D efforts in target developments, ion sources and post-acceleration.

After the recognition of the HIE-ISOLDE project by the CERN Research Board, the focus turned last year to the physics programme for our new facility. Thirty-four letters of intent for HIE-ISOLDE were endorsed by the INTC, signed by 284 participants from 76 laboratories in 22 countries. A physics coordination group was put in place, including representatives of the different categories of experiments, in order to define the technical requirements for our scientific programme and discuss their implementation with the project team. Two forward looking workshops were organized in Heidelberg and Lund respectively, in order to initiate work towards extending the HIE-ISOLDE scientific reach through a storage ring and a magnetic spectrometer/separators. Both generated quite some enthusiasm from the ISOLDE community and beyond and a letter of intent promoting the installation of the TSR ring at CERN, which is summarized in this newsletter, has been endorsed by the INTC.

In local Physics Group news, Magda Kowalska has enthusiastically taken over the job of Physics Coordinator from Alex Herlert who is thanked for his tireless work and dedication to the facility, while Thomas Cocolios has joined as research fellow and

Kara Lynch as new doctoral student. As for myself, the collaboration proposed that I continue as group leader for an additional year, so I should be around until mid-2012. This is also the opportunity to give special recognition to our so-called "long-term" users: senior scientists, post-docs and students who are stationed for extended periods at ISOLDE and whose hugely valuable contribution to the facility and to the group is often taken for granted.

ISOLDE is gearing up for the next running period. The new front-end of the GPS target is undergoing its final tests. The REX vacuum system has been fully renovated, while Faraday cups benefit from an entirely new read-out package. Thanks to the amazing efficiency of Jenny Weterings and the CERN financial team, we have been supporting users through ENSAR since the first day of the contract on Sept. 1, 2010 and will continue throughout the next running period. Many colleagues from around Europe and the world paid us a visit last year at the occasion of the EURORIB10 and HFI-NQI 2010 conferences, both hosted by ISOLDE. This year will culminate with our annual workshop and user's meeting (Dec. 5-7, 2011) which will be the opportunity to celebrate the tenth anniversary of physics with REX, recently documented in a comprehensive review article.

All the CERN accelerators including PSB will be stopped in 2013, so the technical team will do its very best this year and next so you can stock up on data to weather the shutdown. And when you come to ISOLDE for your run, don't forget to send a representative to the weekly group meeting on Wednesday at 14:00 in the visitor's room: we're really interested to learn about your accomplishments!

Yorick Blumenfeld

Information for Users:

CERN Computer accounts

As from 1st January 2011, when you register as a CERN User a computer account will automatically be created for you. In order to activate your account you should contact the CERN Service desk on 77777. Once your account is activated you will have 5 days in which to follow the computer security course and accept the CERN computing rules via <http://www.cern.ch/account> .

Shuttle bus – Extended hours

The timetable of the regular CERN weekday shuttle service from the main building 500 to the airport has been extended with the last shuttle now leaving CERN at 19:00. The schedule of the shuttle bus can be found here: http://gs-dep.web.cern.ch/gs-dep/groups/sem/ls/ShuttleService/Circuit4/Circuit4_bldg500.htm

Dosimetry service

The dosimetry service has now moved to the ground floor of building 55. The service is open daily 8:30 to 12:00. Please note that the service is closed in the afternoons.

Jenny Weterings

Remote access to CERN electronic resources

It is now possible to access directly from your own computer, wherever you are, all electronic journals, dictionaries and encyclopedias that are licensed by the CERN library. To use the service, please follow the instructions at:

<http://library.web.cern.ch/library/Library/remote.html>

General Services at CERN

If you ever spent hours looking for the person to contact when you had to dispose of chemicals used at your ISOLDE experiment, didn't know what to do with wooden pallets, or wanted to know if the piece you ordered has already arrived at CERN, there is now an online portal with a list of CERN General Services and contacts: www.cern.ch/service-portal. You can use it to look for the service which interests you, you can report a problem or incident which should be solved, and you can also follow the progress of all your requests submitted online, via email, or by phone (to 77777 or 78888). In addition, there is a short summary of the various services available at http://gs-dep.web.cern.ch/gs-dep/services/ListGS_IS_Services.pdf.

Equipment at the disposal of all experiments

Following discussions with the CERN radioprotection team, ISOLDE will now provide primary vacuum pumps to all visiting experiments. All teams are kindly requested not to bring their pumps (unless they plan to leave them at ISOLDE for a few years). We also have several spare turbopumps and vacuum gauges which you are welcome to use as well. If you need any of this equipment please contact, a few days in advance, julien.thiboud@cern.ch who will maintain the pumps.

In the few last months we have also acquired or rented new electronics modules which will be stored in the ISOLDE hall extension in a dedicated cupboard. You have now at your disposal: Canberra MCA DSA1000 with Genie™2000 interface on a laptop, 2 Ortec 113 preamplifiers for stretching scintillator pulses, 2-channel CAEN N1471A 5.5-kV power supply for Ge and other detectors. Several NIM crates

have been also tested and approved by the CERN electronics-pool team. Next to the analog DAQ system, which was described in the 2006 ISOLDE Newsletter, since 2010 we have also a small digital Camac-based DAQ system consisting presently of 2 DGF rev. F modules by Xia, Jorway Camac controller and a PC with the acquisition software developed by the MINIBALL Collaboration. If you would like to use any of these devices, please contact me in advance, as the key of the cupboard is kept in my office.

Mid-term storage space for experiments

Since some time the previous long-term storage (bldg 133) behind ISOLDE does not accept any equipment belonging to the PH Department or to ISOLDE experiments. Instead, a limited space is available in bldg 185 where storage for maximum 2 years can take place. Please contact me if you would like to move there your equipment presently stored in ISOLDE or in the offline lab (bldg 275).

ISOLDE Kitchen

In order to keep the ISOLDE kitchen in good order also during the running period, based on input from the local group, we have implemented new rules for food storage: we have bought two dozen transparent plastic containers which also fit in the fridges. All kitchen users are kindly requested to store their food in the boxes, and label it clearly with their name or experiment name and the date until which they will use it. All food which is not in the boxes, which is not labelled or where the marked date has passed, will be considered as free food for everybody's use. Thank you in advance for respecting this simple rule!

Magdalena Kowalska

Experiment reports:

IS430: Study of neutron rich Be isotopes

The third and latest experiment of the IS430 project was performed at ISOLDE in September 2010.

The IS430 experiments were designed to study neutron rich beryllium isotopes through one-neutron transfer and scattering reactions at low energy. ^{11}Be isotopes impacted on a deuteron target with low energy to produce both ^{10}Be and ^{12}Be . The one-neutron transfer enables a study of the inversion of states leading to the breaking of the $N=8$ magic number in ^{12}Be through single particle excitations. Furthermore the halo structures in all three nuclei have been investigated. ^{11}Be can be described as a ^{10}Be core, mainly in the ground state, with a loosely bound neutron. The neutron transfer in the (d,p)-reaction makes it possible to study the two-neutron halo structure of ^{12}Be , while the opposite transfer, leading to the (d,t)-reaction, enables a study of the structure of the ^{10}Be structure.

REX-ISOLDE was used to produce a ^{11}Be beam at 2.85 MeV/u, and the MINIBALL setup with T-REX for particle detection was used. The experiment ran for four days with an average beam intensity of 5.5×10^6 /s, giving a total of almost 400,000 identified protons.

Figure 1 shows the excitation spectra for $^{10,11,12}\text{Be}$. Clear structures are shown with high statistics, but γ rays are needed to distinguish the excited states in ^{12}Be and removing the background.

Figure 2 shows γ -gated excitation spectra for the 2^+ and 1^- states in ^{12}Be . Even with the γ -gates, the statistics are more than sufficient to extract cross sections. Angular distributions have been made, but the efficiency of the MINIBALL is still to be

finally determined in order to get the correct normalization.

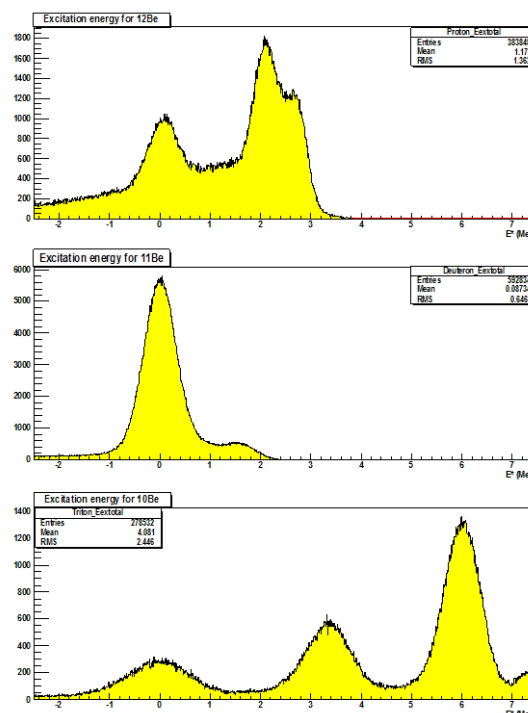

Figure 1: Excitation spectra for ^{12}Be (top), ^{11}Be (middle) and ^{10}Be (bottom). Clear structures are seen, but a considerable background is present for ^{12}Be .

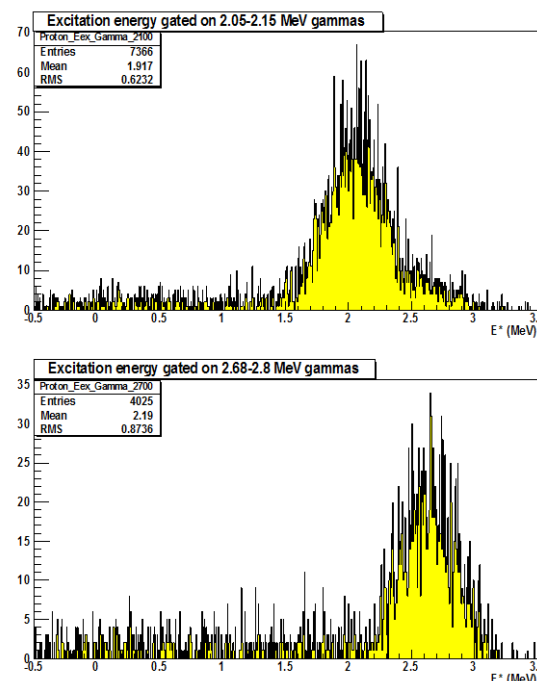

Figure 2: Gamma gated excitation spectra for ^{12}Be 2^+ (top) and 1^- (bottom).

Jacob Johansen, IFA

IS433: A Penning Trap simulation program for the WITCH experiment that utilizes a Graphics Card to calculate Coulomb interactions

The WITCH setup at ISOLDE is designed to search for exotic interactions in the weak interaction Hamiltonian by measuring the beta neutrino angular correlation coefficient, a , very precisely (order of 1 %) [1]. Since the neutrino is difficult to observe, the recoil energy spectra after beta decay will be measured and used to extract a and deduce limits on scalar currents. Therefore WITCH combines two Penning traps (one to prepare the ion cloud and one to store it as the radioactive source for the measurements), with a retardation spectrometer to probe the energy after the decay [1]. To determine a , the measured recoil energy spectra will be fitted with spectra generated by a particle tracking routine [2]. The input of this tracking routine will be the positions and velocities of the ions in the WITCH upper Penning Trap. In order to generate correct spectra that will lead to a precise determination of a , one has to know the cloud's initial velocity-, and energy distribution. Since the ion cloud consists of 10^6 ions, calculating the Coulomb interaction between all particle pairs will dominate the simulation time. To this end the *Simbuca* simulation package was developed [3].

Simbuca speeds up the simulation time tremendously by calculating the Coulomb interaction on a graphics card and was initially developed for the WITCH experiment. The program also incorporates three realistic buffer-gas models, the possibility of importing realistic electric and magnetic field maps and different order integrators with adaptive step size and error control. Thanks to the program's

modularity, certain parts of it can be used for simulations of charged particles in other environments like RFQs, Paul traps, or gas collision investigations. The software is released under the GNU General Public License and is free for use [4].

In 2007, an optimized algorithm for N-body simulations was presented [5]. The idea behind this approach is to accelerate the calculation of the N-body gravitational interaction by calculating the exerted force on a Graphics Processing Unit (GPU). Three characteristics of the calculation make it well suited for this approach. First, the calculation of pair wise interaction is relatively simple, because only 20 floating point operations are needed to calculate the Coulomb force between two particles. Second, each particle interacts with all the other particles and hence parallelism is straightforward. Third, in 2006, CUDA, a C-like programming language for GPUs, was developed which allows programming without the need for in-depth knowledge of any graphics library. All this renders the GPU very well suited to calculate the Coulomb interaction. Hamada and Iitaka developed the Chamomile scheme to calculate gravitational N-body interactions on a programmable graphics card and implemented this in the *Cunbody-1* library [5].

Since the Coulomb force and the gravitational force have the same structure one can scale the output of the library to obtain the Coulomb force between the ions, as is done in *Simbuca*.

To evaluate the gain from applying the Chamomile scheme to a GPU, simulations were performed for different numbers of particles with the Coulomb interaction using both a CPU and a GPU. The test system consisted of an Intel i7@3.07 GHz, 8 GB RAMDDR2, a 64-bit SUSE 11.1 operating system and a GPU with a GTX 470 chipset. Figure 1 shows the factor that is gained in

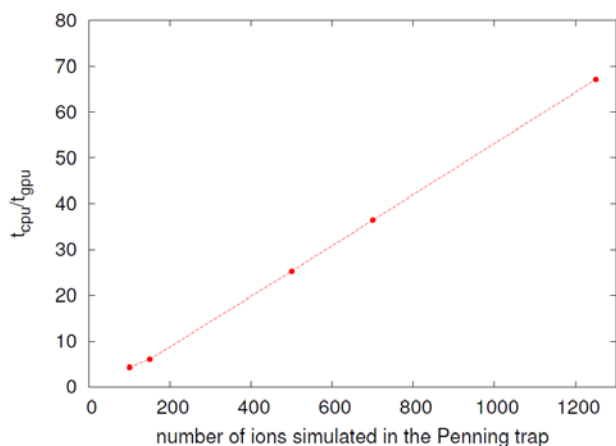

Figure 2: The x-axis represents the number of particles that are simulated. The y-axis marks the factor that is gained in time when using a graphics card instead of a conventional CPU (the Coulomb interaction on a CPU is computed on a single core). As can be seen, the GPU is a factor of 50 faster if 1000 particles are simulated. This gain factor increases if more particles are simulated.

time when using a GPU.

To get an idea of the performance, 10 000 particles moving for 100 ms in a buffer-gas filled Penning trap were simulated. This was found to take 5.5 days of simulation time on a GTX 470 GPU. From extrapolation, one can conclude that doing the same simulation on a CPU would take roughly 4.5 years.

Furthermore three different, collision models are implemented in *Simbuca* as well. The Langevin model calculates the collision chance based on the polarizability of the buffer-gas atoms. The K_0 model determines the collision probability using the experimentally known ion mobility data. The third and last model is the SIMION HS1 model[6]. This model compares the distance that an ion travelled in the gas with the mean free path to determine the collision chance. It was shown that both the Langevin and the K_0 model simulate the behavior of the experimental data better than the HS1 model that is commonly used in SIMION, see figure 7 in [3].

Simbuca is a versatile package that is easy to use, powerful and calculates Coulomb

interactions between particles on a graphics card to speed up the simulation time tremendously. *Simbuca* can be utilized on a normal CPU as well and can be applied to simulate charged particles in Paul traps or RFQs with minor modifications. The software is released under the GNU General Public License and can be downloaded for free [4].

[1]: M. Beck et al. (2011) accepted for Eur. Phys. Jour. A <http://arxiv.org/abs/1008.0207v1>

[2]: F. Glück, to be published

[3]: S. Van Gorp et al., accepted in Nucl. Instr. and Meth. (2011)

<http://dx.doi.org/10.1016/j.nima.2010.11.032>

[4]: <http://sourceforge.net/projects/simbuca/>

[5]: T. Hamada, T. Iitaka, (2007),

<http://uk.arxiv.org/abs/astro-ph/0703100>

[6]: A.D. Appelhans and D.A. Dahl, Int. J. Mass. Spectrosc. 216(3) (2002) 269-284

S. Van Gorp

IS443 & IS501: Paramagnetism in Fe/Mn implanted ZnO

Since dilute magnetic semiconductors obtained by doping of e.g. ZnO with 3d-metal impurities were theoretical predicted by Dietl *et al.*, [1] this field has in recent years become a major research focus, due to their potentiality as semiconductor-compatible magnetic components for spintronic applications.

Experimentally, controversial results have been obtained and common understanding on the ZnO magnetic properties is lacking [2, 3]. Some groups have suggested unintentional precipitation of 3d-metal impurities to be the source of at least some of the positive findings of dilute magnetism [4].

Samples of interest are implanted using a short-lived radioactive ions (^{57}Mn , $T_{1/2} = 1.5$ min) where the total implanted dose is held below 10^{-4} at. % allowing us to study truly

dilute systems and avoid any potential precipitation. The ^{57}Mn decays to the Mössbauer state of ^{57}Fe and the hyperfine interactions of the Fe nuclei are studied using resonance detectors sensitive to the 14.4 keV emitted gamma radiation. The probed hyperfine interactions include (amongst others) determination of the valence state of Fe and magnetic interactions.

The central part of all spectra is dominated by lines originating from substitutional Fe^{2+} (D2) and interstitial Fe (D3). The spectrum obtained without external magnetic field, show lines from the magnetic hyperfine interactions on the wings of the spectrum, but the origin of the interactions is difficult to determine. In a sufficiently large external magnetic field ($B_e > 0.3$ T), the electronic states decouple from the nuclear states, and the lines can be interpreted in terms of sextet lines originating from three electronic Kramer doublets ($S_z = \pm 1/2, \pm 3/2$ and $\pm 5/2$), due to slow-paramagnetic relaxation of Fe^{3+} . This interpretation of the obtained spectra is also valid in the angle dependent measurements, where the sextets from the three Kramer doublets show the expected angular dependence of the relative intensity ratios.

This slow paramagnetic state is evidence that the spin of the Fe^{3+} is not coupled to the defects created in the implantation process (which should lead to fast spin-spin relaxations) and demonstrates that individual dilute Fe atoms themselves are not the seed of magnetism in dilute magnetic semiconductors.

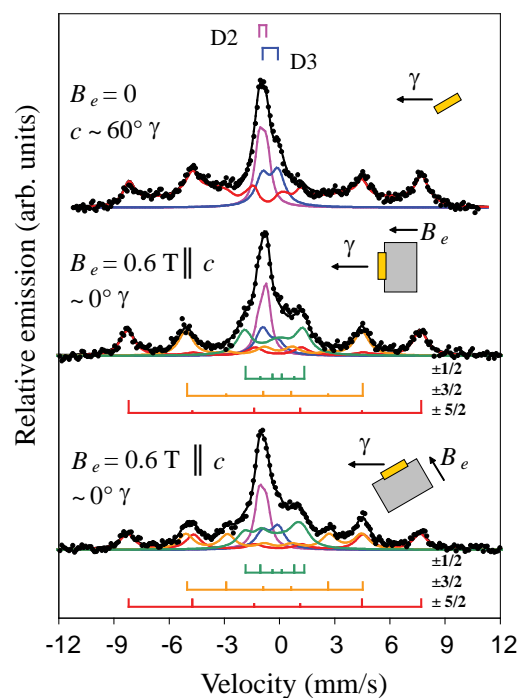

Fig. 1: ^{57}Fe Mössbauer spectra obtained after implantation of ^{57}Mn in ZnO single crystals at room temperature under the conditions indicated (adapted from [5]) The measurements in external magnetic field are obtained by placing the sample (indicated in yellow) on a permanent (rotating) magnet (indicated in gray).

The spin-lattice relaxation rate of Fe^{3+} in ZnO is comparatively different from other studied materials in light of its temperature dependence (cf. Fig 2).

While the results obtained for Fe^{3+} impurities in $\alpha\text{-Al}_2\text{O}_3$ (and MgO [6]) show the expected T^2 dependence at elevated temperatures ($T > \theta_D/3$, θ_D the Debye temperature of the material), the results for Fe^{3+} in ZnO show an unexpected different temperature dependence.

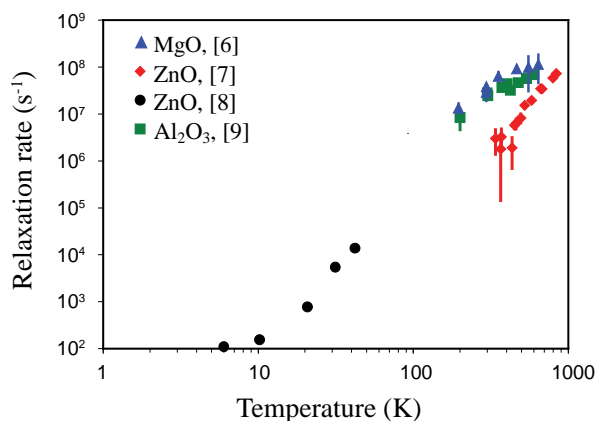

Fig. 2: Spin-lattice relaxation rate of Fe^{3+} determined from temperature dependent measurements [6], showing data for Fe^{3+} in ZnO [7, 8] α - Al_2O_3 [9] and MgO[6]

References:

- [1] T. Dietl *et al.*, *Science* **287** (2000) 1019.
- [2] A. Koji, *Science* **312** (2006) 1883.
- [3] Ü. Özgür *et al.*, *J. Appl. Phys.* **98** (2005) 041301.
- [4] K. Potzger and S. Zhou, *Phys. Status Solidi B* **246** (2009) 1147.
- [5] H. P. Gunnlaugsson *et al.*, *Appl. Phys. Lett.* **97** (2010) 142501.
- [6] T. E. Mølholt *et al.*, *Hyp. Int.* **197** (2010) 89.
- [7] H. P. Gunnlaugsson *et al.*, *Hyp. Int.* **197** (2010) 43.
- [8] J. Tribollet *et al.*, *Europhys. Lett.* **84** (2008) 20009.
- [9] H.P. Gunnlaugsson *et al.*, *Hyp. Int.* **198** (2010) 5

H.P. Gunnlaugsson

IS447: First extraction of neutron-rich gold isotopes at ISOLDE

An experiment with the aim of studying long-lived, isomeric excited states in the neutron-rich $^{201,203,205}Au$ ($N=122-126$) isotopes [1] was performed at ISOLDE in September 2010. It was expected that similarly to ^{205}Au [2], the $^{201,203}Au$ isotopes exhibit long-lived $11/2^-$ proton-hole isomeric states, possibly with lifetimes of several seconds.

Gold nuclei were produced during spallation of a Uranium Carbide target at ~ 2000 °C, impacted by a ~ 1.6 μA primary beam of 1.4 GeV protons provided by the PS-Booster at CERN. The gold atoms were selectively ionised by the Resonant Ionisation Laser Ion Source (RILIS). A three-step ionisation scheme was previously developed [3]. The secondary beam was accelerated via high-voltage (40 kV) towards the High Resolution Separator (HRS), used to select and transmit reaction products with particular mass A. Finally the ions were transported to a measurement station and implanted onto a magnetic tape for a number of seconds, before being moved into view of two HPGe detectors and one mini-orange spectrometer where data was collected for between 10-50 s. The activity was then moved away and the process repeated multiple times. The mini-orange spectrometer consisted of 6 permanent magnets and a liquid nitrogen cooled Si(Li) detector. The absolute efficiencies of each HPGe detector were 0.5-3.0 % and 0.2-1.5 % for photon energies between 122 - 1408 keV. A digital data acquisition system was used. A similar setup was used by A.Y. Deo *et al* in a previous study [4].

The beta decay of the ground-states of ^{201}Au and ^{202}Au have been observed. Known γ -ray transitions in the nuclei ^{201}Hg and ^{202}Hg have been identified [5-6], as shown in figure 1. For $A=201$, γ -rays with energies 527, 543, 553 and 613 keV were observed. For $A=202$, γ -rays with energies 440 and 908 keV were observed in the single spectrum, as well as 908, 1125 and 1306 keV transitions in coincidence with the 440 keV γ -ray.

The spectrum measured with the mini-orange spectrometer for the $A=201$ mass setting is shown in figure 2. With RILIS deactivated (blue plot), the spectrum is dominated by the internal conversion

transitions associated to the decay of a $13/2^+$, 60.8(18) s isomeric state in ^{201}Pb via 29.1 keV transition [5]. However, with RILIS activated (red plot) these transitions are superimposed upon a large continuum associated to the β^- decay of ^{201}Au . Time spectra were independently taken by 'in-house' ISOLDE β -detectors (see figure 3). With RILIS deactivated, the decay showed only a short-lived, $t_{1/2} = 59(3)$ s, component, which is the half-life of the ^{201}Pb isomer. With RILIS activated, the short-lived component and a much longer-lived component were observed, the latter with $t_{1/2} = 25(2)$ min, which is consistent with the ground state half-life, 26.0 (8) min [5], of ^{201}Au .

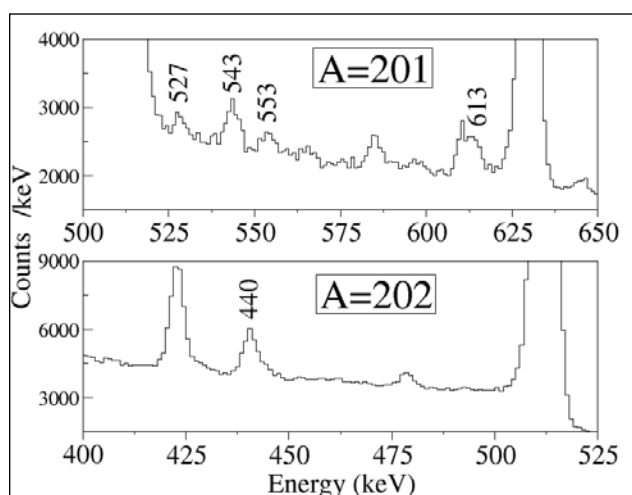

Figure 1. Delayed γ -ray spectra associated with the mass settings $A=201$ and $A=202$. The labelled peaks correspond to known γ -rays from the β decay of ^{201}Au and ^{202}Au into ^{201}Hg (top panel) and ^{202}Hg (bottom), respectively.

Based on the measured γ -ray spectra, the intensity of the implanted ^{201}Au and ^{202}Au were estimated to be $\sim 6 \times 10^4 \text{ s}^{-1}$ and $\sim 2 \times 10^3 \text{ s}^{-1}$, respectively (for 1.6 μA proton beam). No γ -rays from the decay of the more exotic $^{203-205}\text{Au}$ nuclei were observed, and their beam intensities will be determined from the β continuum spectra taken with the mini-orange spectrometer.

In ^{201}Au the $nh_{11/2}^{-1}$ state can have lifetimes in order of seconds or in order of hundreds of microseconds depending whether the predicted $7/2^+$ state is above or below the $11/2^-$ at 594(5) keV [5]. The transition from the isomer is expected to be much more intense than the γ lines from the β decay of the ground-state [5]. Assuming a relatively fast release of the gold nuclei from the target, the non-observation of the 594(5) keV γ -ray transition suggests that the half-life of this state is much shorter than seconds, i.e. the yrast $7/2^+$ state is below the $11/2^-$ isomer.

The study was performed as part of a collaboration between the University of Surrey (Guildford, UK), IFIC (Valencia, Spain), Complutense University of Madrid (Madrid, Spain), The University of Manchester (Manchester, UK) and Osaka University (Osaka, Japan). The expert assistance of the ISOLDE and RILIS staff is gratefully acknowledged.

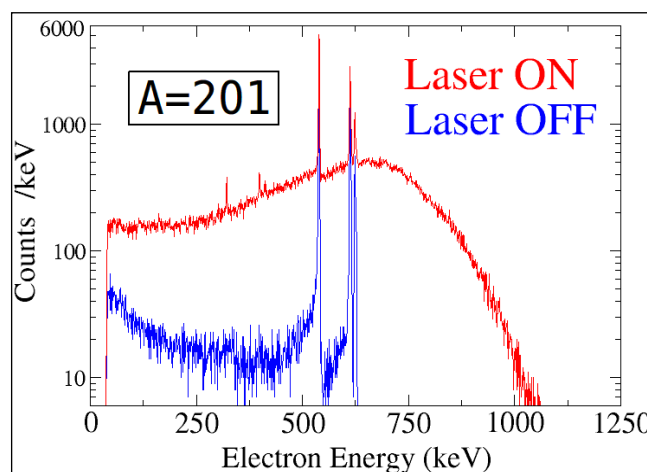

Figure 2. Delayed electron spectra associated with the mass setting $A=201$ as measured with the mini-orange spectrometer. The red and blue plots correspond to data collected with and without laser ionization of the gold nuclei, respectively. With the laser activated, a large continuum from the β decay of ^{201}Au is observed.

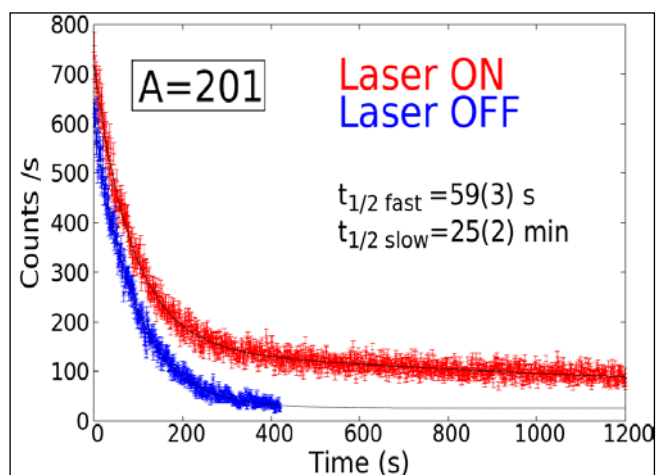

Figure 3. Time spectrum associated with the mass setting $A=201$ as measured with the ISOLDE Si detectors. The red and blue plots correspond to data collected with and without laser ionization of the gold nuclei respectively. With the laser activated, both 'fast' and 'slow' decay components are clearly observed, the latter having $t_{1/2}=25(2)$ min, consistent with the ground state, $t_{1/2}=26.0(8)$ min [5], of ^{201}Au .

[1] Zs. Podolyák et al, CERN-INTC-2006-021, INTC-P-212 (2006).

[2] Zs. Podolyák et al, Phys. Lett. B 672 116 (2009) 116.

[3] B.A. Marsh et al, Hyperfine Interact. 171 (2006) 109.

[4] A.Y. Deo et al, Phys. Rev. C 81 (2010) 024322.

[5] F.G. Kondev, Nuclear Data Sheets 108 (2007) 365.

[6] S. Zhu et al, Nuclear Data Sheets 109 (2008) 699.

Michael Bowry

IS449: Isotope shift measurement of ^{12}Be

The nuclear charge radius of ^{12}Be is of great interest for several reasons: First of all, it is the connecting nucleus between the one-neutron halo nucleus ^{11}Be and the four-neutron halo ^{14}Be . Furthermore, it is an $N=8$ shell-closure isotone, where clear evidence for a breakdown of the shell closure has previously been reported [1].

Finally, recent measurements using elastic proton scattering in inverse kinematics indicated an extended matter distribution

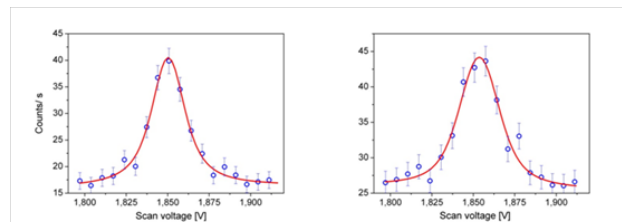

Fig. 1: Fluorescence spectra of ^{12}Be in collinear (left) and anti collinear (right) excitation.

[2]. The charge radius will provide a model-independent benchmark for nuclear structure studies and combined with theoretical calculations it can provide a signature of whether ^{12}Be 's structure is more of p^2 - type or of s^2 - & d^2 -character. In the first case, the charge radius is expected to be smaller than that of ^{11}Be whereas in the second case it should be similar or even larger [3].

Whilst IS 449 measured the charge radii of the isotopes ^7Be to ^{11}Be successfully in 2008, a measurement of ^{12}Be at that time was not feasible since this isotope is only produced with rates that are roughly three orders of magnitude smaller than the yields of ^{11}Be . Hence, we decided to adapt the technique of ion-photon coincidence to reduce background and increase our sensitivity. Additionally the measurements

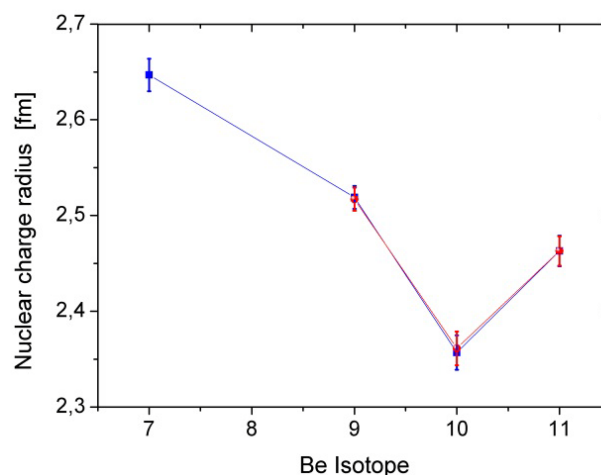

Fig. 2: Nuclear charge radii of the beryllium isotopes ^7Be to ^{11}Be from 2008 and 2010 measurements.

were gated to each proton pulse, due to the short half-life of ^{12}Be (20 ms). With this technique, we were able to record resonances of ^{12}Be in the D_1 ($2s_{1/2} \rightarrow 2p_{1/2}$) and D_2 ($2s_{1/2} \rightarrow 2p_{3/2}$) atomic transitions in Be^+ . To overcome the systematic uncertainties in the isotope shift measurements caused by the 10^{-4} uncertainty of the acceleration voltage, absolute transition frequencies ν_c and ν_a in collinear and anti collinear geometry, respectively, were measured and combined to obtain the absolute transition frequency $\nu_0 = (\nu_c - \nu_a)^{1/2}$ in the rest frame of the ion. More details on the frequency-comb based laser system can be found in [4]. Resonance lineshapes of the isotope ^{12}Be in the D_1 transition are presented in Fig. 1. Such a measurement of ^{12}Be took about 2 hours and in total 25 similar resonances in the D_1 and 15 in the D_2 line were recorded. We were also able to remeasure the isotope shifts of $^{10,11}\text{Be}$ during the beamtime and results are shown in Fig. 2. An excellent agreement with the data from the 2008 campaign is observed. Furthermore, we were able to reduce the uncertainties by a systematic investigation of recoil-induced shifts and a direct link of our reference Rb-clock to the GPS time standard. Analysis of the ^{12}Be isotope shift is still ongoing, but a similar uncertainty to that of the other isotopes is expected.

We thank the ISOLDE technical group for support.

- [1] A. Navin *et al.*, Phys. Rev. Lett **85**, 266 (2000).
- [2] S. Illieva, PhD Thesis, University of Mainz (2009). (<http://ubm.opus.hbz-nrw.de/volltexte/2009/1890/>)
- [3] Thomas Neff, GSI, private communication
- [4] W. Nörtershäuser *et al.*, Phys. Rev. Lett. 102, 062503 (2009).

W.Nörtershäuser for the BeTINA and COLLAPS collaborations

IS466: Identification of beta-delayed fission in ^{178}Tl and ^{202}Fr

A dedicated program of beta-delayed fission (BDF) studies in the very neutron-deficient lead region was initiated at ISOLDE in 2008 (IS466 experiment). The feasibility of such studies was proven and a very unexpected result – an asymmetric fission mass-distribution in the BDF of the ^{180}Tl isotope – was obtained [1].

As a continuation of this program, a new experiment has been carried out in 2010 in which the isotopes ^{178}Tl and ^{202}Fr were studied. The same experimental setup (a Windmill system) as used in the previous run was also used in the new run. The uniqueness of ISOLDE for these studies is that it provides pure Tl beams, using a combination of the resonance ionization laser ion system (RILIS) and mass separation (GPS or HRS).

The neutron-deficient isotope ^{178}Tl was produced via the spallation of a UC_x target, resonantly ionized and mass separated by the GPS. The pure beam of ^{178}Tl ions with an average intensity of ~ 0.1 ion/s was implanted on a thin ($20 \mu\text{g}/\text{cm}^2$) carbon foil of the Windmill system. Alpha decays and fission events were detected by one silicon detector installed behind the foil. Two HPGe detectors recorded the emitted gamma rays, allowing for the measurement of particle-gamma/X-rays coincidences.

During the run approximately 10^4 alpha and beta decays of ^{178}Tl were recorded. The much higher statistics recorded in this experiment compared to the previous study on this isotope by Rowe *et al* [2], and the possibility to measure alpha-gamma coincidences, will allow a more detailed investigation of this isotope to be performed.

For the first time the BDF of ^{178}Tl has been identified with 8 fission events detected in the range of 40-90 MeV, which will allow the deduction of the βDF probability for this isotope.

The isotope ^{202}Fr was also studied in this experiment using a surface-ionized beam of ~ 60 ions/s. Very high statistics were collected for alpha decay (1.7×10^6 alpha decays). Fig.1 shows alpha-decay spectrum measured in the Si detector, which demonstrates that only decays of ^{202}Fr and its direct daughters (^{198}At , after alpha-decay) and ^{202}Rn (after beta decay) have been observed. Using the alpha-gamma coincidence measurements a detailed decay scheme of ^{202}Fr and ^{198}At will be constructed.

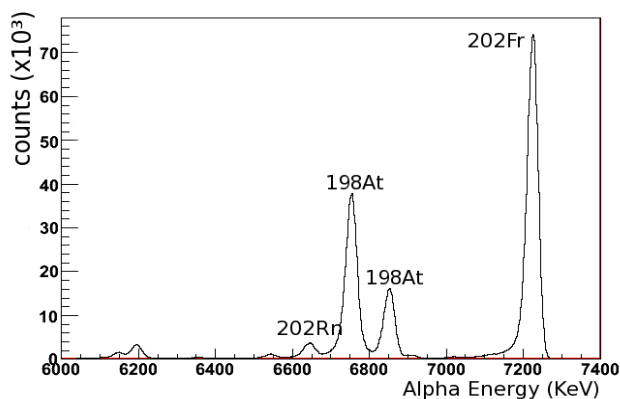

Fig.1: Alpha spectrum collected during the ^{202}Fr measurements.

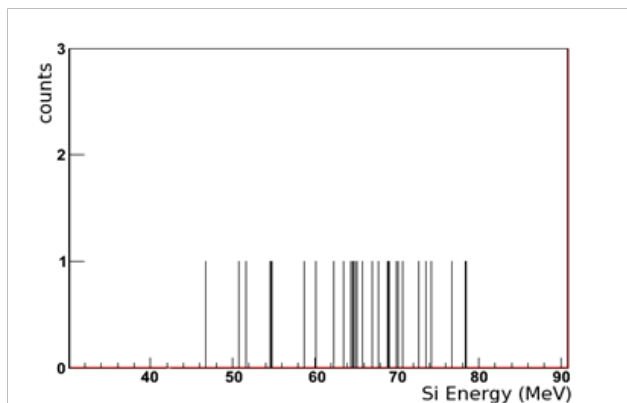

Fig.2 : 34 fission event attributed to βDF of ^{202}Fr

The BDF has also been identified for the first time for this isotope with 34 fission events observed in the range of 40-90 MeV, see Fig.2. The BDF branching ratio and its probability will be deduced. The data analysis is ongoing.

References:

- [1] A. N. Andreyev et al. PRL **105**, 252502 (2010)
- [2] M. W. Rowe et al. Phys. Rev. C **65**, 054310 (2002)

A. Andreyev on behalf of IS466 collaboration

IS475: Octupole Collectivity – Coulomb Excitation of ^{224}Ra

There is considerable theoretical and experimental evidence that atomic nuclei can assume reflection asymmetric shapes that arise from the octupole degree of freedom [1]. From a microscopic point of view, the wave functions of low-lying 3^- octupole excitations must contain components which include the intruding unique parity state (l,j) . Because of the nature of the octupole-octupole interaction in nuclei, strong octupole correlations arise when the Fermi level lies between this intruder subshell and a subshell with $\Delta j, \Delta l=3$, giving rise to $[l, j; l-3, j-3]$ particle-hole configurations at relatively low excitation energies. The strongest correlations occur near the proton numbers $Z = 34, 56$ and 88 and the neutron numbers $N = 34, 56, 88$ and 134 where, for the heaviest nuclei, an octupole deformation can occur in the ground state. Indeed, at these values of Z and N , nuclei exhibit phenomena associated with reflection asymmetry such as odd-even staggering of the positive- and negative-parity yrast bands in even-even nuclei [2], parity doublets in odd mass nuclei [3]; and enhanced E1 moments due to a division of

the centres of charge and mass [4]. The only observable that provides unambiguous and direct evidence for enhanced octupole correlations in the nuclei is the E3 matrix element [5,6], and the measure of octupole correlations in the ground state is the $B(E3; 0^+ \rightarrow 3^-)$.

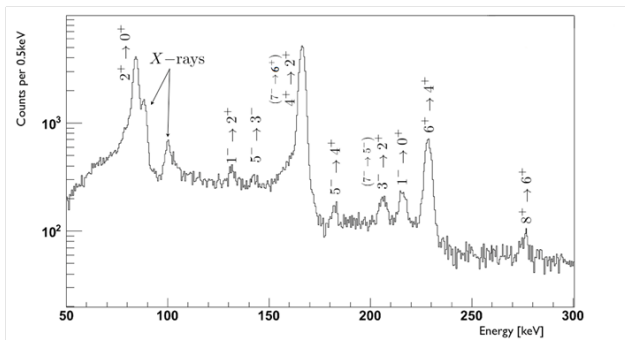

Figure 1: Spectrum showing de-excitation gamma-rays from ^{224}Ra after Coulomb excitation with ^{112}Cd target at 2.83 A.MeV

In the mass region where octupole correlations are expected to be largest, i.e. at $Z = 88$ and $N = 134$, there is a lack of spectroscopic data on E3 moments. So far, only for ^{226}Ra , with its comparatively long half life of 1600 years, has it been possible to measure the $B(E3)$ strength using Coulomb excitation [6]. Using the unique capabilities of ISOLDE to produce high intensity radioactive ion beams in the mass $A=220$ region, and the ability of REX to accelerate these ions to 2.83 A.MeV, ^{224}Ra was Coulomb excited by ^{112}Cd and ^{120}Sn targets in inverse kinematics.

The ^{224}Ra beam was delivered to the MINIBALL target position at an intensity of 4.2×10^5 pps for a total of 11 hours. Additionally, data was taken for 44 hours in an "offline mode" without protons on the primary UC_x target. An order of magnitude drop in the intensity was observed in this mode but radium was still produced from the decay of long-lived parent isotopes remaining in the irradiated target material for many hours after proton impact.

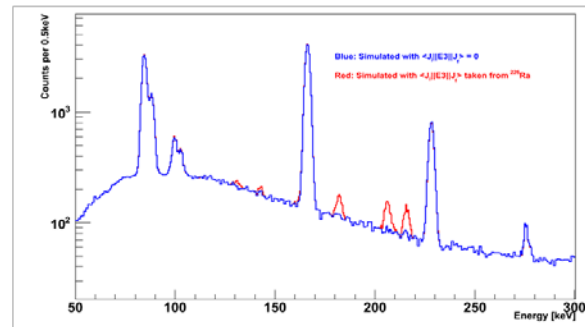

Figure 2: Comparison of de-excitation gamma-ray spectrum with E3 moment equal to that in ^{226}Ra (red) and equal to 0 (blue) simulated using the GOSIA code.

Figure 1 shows the total de-excitation gamma-rays, Doppler corrected and with a random background subtraction. Negative parity states up to $J^\pi=5^-$ are observed. The population and subsequent decay of these states during the excitation process has been simulated using the GOSIA [7] code for a given set of matrix elements and other known information such as lifetimes, branching ratios, etc. These simulations (Fig. 2) reproduce the experimental spectrum only when a significant E3 moment is assumed. To extract the magnitude of the E3 moment, a more detailed analysis is required and is ongoing.

- [1] P. A. Butler and W. Nazarewicz, *Rev. Mod. Phys.* **68**, No.2, (1996) 349
- [2] J. F. C. Cocks et al., *Phys. Rev. Lett.* **78**, (1999) 2920; *Nucl. Phys A* **645**, (1997) 61
- [3] M Dahlinger et al., *Nucl. Phys. A* **484**, (1997) 337
- [4] P. A. Butler and W. Nazarewicz, *Nucl. Phys. A* **533** (1997) 249
- [5] R.Ibbotson et al., *Phys. Rev. Lett.* **71** (1997) 1990
- [6] H. J. Wollersheim et al., *Nucl. Phys A* **556**, (1993) 261
- [7] T. Czosnyka et al., *Bull. Am. Phys. Soc.* **28**, (1983) 745

Liam Gaffney

IS476: Study of low-lying states in ^{30}S from beta delayed proton emission of ^{31}Ar

A detailed knowledge of the energy levels in exotic nuclei, especially the ones just above the proton threshold, is important for understanding astrophysical processes such as hydrogen burning in x-ray bursts. Because of its long lifetime ^{30}S is a critical waiting point nuclei along the rp- and qp-process path where it is produced in the $^{29}\text{P}(p,\gamma)^{30}\text{S}$ reaction.

Two states just above the proton threshold have been predicted to be important to the process: A 3^+ resonance at 4733(40) keV and a 2^+ resonance at 4888(40) keV predicted with the isobaric multiplet mass equation (IMME). Two resonances close to these energies have just been identified by Setoodehnia *et al.* [1] at 4688.0(4) keV and 4810.4(6) keV using the $^{28}\text{Si}(^3\text{He},n\gamma)^{30}\text{S}$ reaction.

^{31}Ar beta decays into ^{31}Cl , which then decays by single proton emission to ^{30}S or by double proton emission to ^{29}P through intermediate states of ^{30}S . The beta delayed proton emission from ^{31}Ar gives then another way to study the states of ^{30}S . In a previous experiment from 1997 [2] the lowest resonance found in ^{30}S was at 5217.4(7) keV. In the newest experiment from 2009 a silicon cube detector, consisting of 6 DSSSDs in telescope, was used to give a better and more uniform angular coverage for proton detection. Additionally two MINIBALL cluster detectors were used to detect the gammas.

From the gamma spectrum it is possible to extract information about the energy of the lowest lying states of both ^{30}S and ^{29}P .

Figure 1 shows the gamma spectrum made with a time gate of 150 ms to get rid of Nitrogen contamination in the beam. Furthermore a gate was set on protons that could be identified in 4 of the 6 telescopes (because the back detector was non-functional in two of the telescopes) when more than 800 keV was deposited in the DSSSDs.

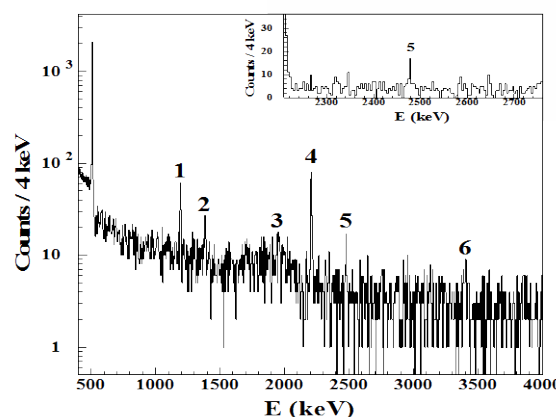

Fig. 1: Energy spectrum of time and proton gated gammas (not corrected for doppler shift). Top corner is a zoom around peak 5 with linear y-axis.

The first and second excited state of ^{30}S are clearly identified (peak 4 and 6 to the ground state and peak 1 between the two). Also the decays of the two lowest lying states to the ground state in ^{29}P are found (peak 2 and 3). Most interesting though is the peak at 2477(4) keV which most likely corresponds to a gamma decay to the first excited state in ^{30}S at 2210.6(5) keV, which means a resonance at 4688(4) keV corresponding to the proposed 3^+ state.

Although the two-proton spectrum has limited statistics there is for the first time a clear indication of the proton decay from this resonance to the ground state in ^{29}P . With a detailed analysis this will give us the branching ratios of proton and gamma decay from the resonance. Most of the known higher lying resonances can also be identified by proton emission. Studying these in detail will give us a better understanding of the $^{29}\text{P}(p,\gamma)^{30}\text{S}$ reaction.

[1] K. Setoodehnia *et al.*, Phys. Rev. C **83**, 018803 (2011)

[2] H.O.U. Fynbo *et al.*, Nucl. Phys. A **677**, 38 (2000)

Gunvor T. Koldste

IS484: Spin and magnetic moment measurements of neutron-rich $^{48,49,50}\text{K}$ isotopes

Laser spectroscopy on Potassium isotopes can provide a wealth of information on the evolution of single particle levels beyond $N=28$ along with a rare opportunity to characterise the changes in mean square charge radius $\delta\langle r^2 \rangle$ across this shell closure. However, technically this element poses many problems: Firstly, the small size of the optical isotope shifts and upper state hyperfine splitting preclude the beneficial application of high sensitivity techniques such as resonant ionisation spectroscopy. Secondly, the small scale of expected β -decay asymmetry parameters limits the use of β -asymmetry detection. Finally, optical detection of the weak infrared transition is hindered by the low quantum efficiency and high dark current of PMT's sensitive to such wavelengths. In view of these issues it was concluded that a new high-sensitivity, low-background optical detection station should be designed and implemented at the

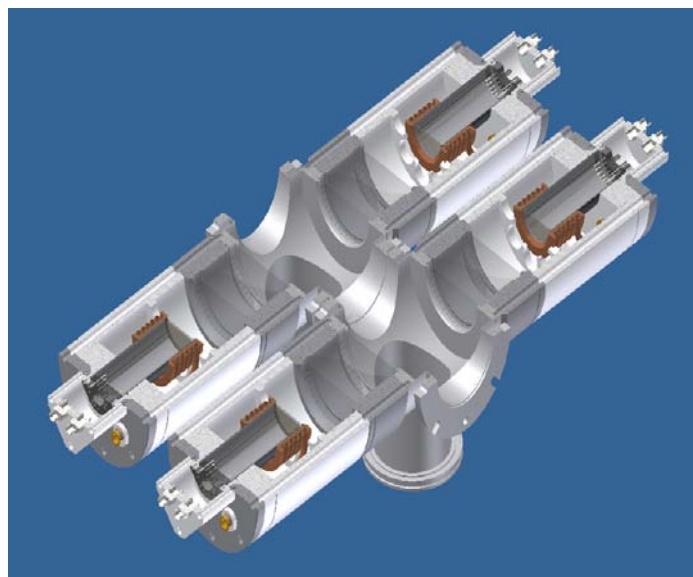

Figure 1: Sectional view of the new optical detection station. Eight 100mm diameter aspheric lenses are used to precisely image the emitted light onto 4 PMT's. These tubes are contained within a clean vacuum environment and cooled to -38°C to reduce dark counts

COLLAPS beam line.

In 2010 the new system, illustrated in Figure 1, was delivered to CERN and tested with off-line beams of Potassium. In these tests it was demonstrated that the problems of low transition strength and poor quantum efficiency had been mitigated by the high geometric collection efficiency. Furthermore background was maintained at an acceptably low level by photomultiplier cooling and the minimisation of scattered light detection via precise imaging.

In November the first online run of IS484 took place, in which high resolution optical spectra of $^{48,49,50}\text{K}$ were recorded for the first time. These scans were linked to and validated by reference scans of the previously measured $^{38,47}\text{K}$. Background suppression via ion beam bunching was used in conjunction with the new optical detection station in order to perform these high sensitivity measurements. Initial analysis of the data obtained in this run has indicated that it is possible to determine all

spins and magnetic moments of the isotopes measured. In addition, this analysis has demonstrated that the observed isotope shifts have an appropriate sensitivity to $\delta\langle r^2 \rangle$ across the $N=28$ shell closure. **Figure 2** demonstrates the $\delta\langle r^2 \rangle$ trend obtained for the few isotopes included in this preliminary analysis. An abrupt shell effect at $N=28$ can be seen along with the previously observed smooth progression between $N=20$ and $N=28$. It is interesting to note that the sharp increase in $\delta\langle r^2 \rangle$ after $N=28$ starts to flatten at $N=31$. Perhaps this is a first indication of a sub shell effect at $N=32$?

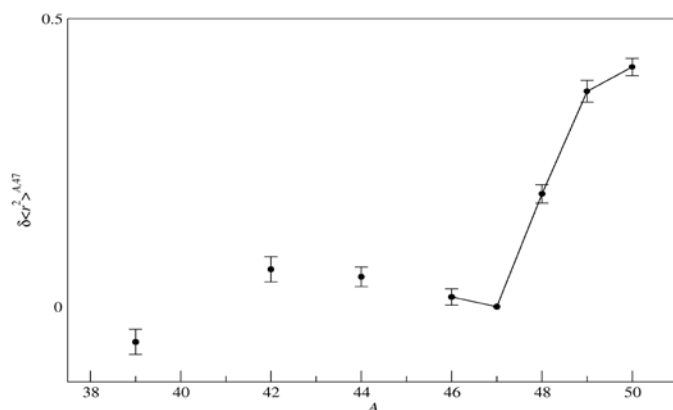

Figure 1: Preliminary analysis of the changes in mean square charge radius along the Potassium isotopic chain.

This year we hope to conclude our IS484 program with a measurement of ^{51}K . It will be interesting to see if the charge radius at $N=32$ decreases giving real evidence for a strong sub-shell effect. Of course a complete characterisation of the $N=32-34$ region will only be possible with the advent of HIE-ISOLDE. With advances in beam purity and yield it is expected that collinear laser spectroscopy will be able to extend both this isotopic sequence and its neighbour Ca to $N=34$.

Besides the experimental program described here, the techniques and apparatus developed in this work will aid and expand other collinear laser spectroscopy work at ISOLDE. The COLLAPS collaboration is now

in the process of extending the capabilities of this new design to cope with all wavelengths routinely used. It is foreseen that all COLLAPS experiments in 2011 will make use of this detection station.

M.L. Bissell on behalf of the COLLAPS collaboration

IS488: Ag(I), Pb(II) and Hg(II) binding to biomolecules studied by Perturbed Angular Correlation of γ -rays (PAC) spectroscopy: Function and toxicity of metal ions in biological systems.

This project is focused on the role of metal ions in biological systems, and applications of PAC spectroscopy to elucidate the toxicity of heavy metal ions at the molecular and electronic level. Most of the systems investigated are proteins. Proteins constitute the nanoscale molecular machinery of living organisms, covering catalysis, transport, structure, and regulation, and metal ions (Ca^{2+} , Cu^{+2+} , $\text{Fe}^{2+/3+}$, Zn^{2+} and others) are integral components and required for functions of about 1/3 of all proteins. Another central kind of biomolecule, nucleic acids (RNA and DNA), carrying our genetic code, has recently been included in the investigations. RNA and DNA may bind heavy metal ions, and such complexes may be designed to display particular properties which are desired in biotechnological applications.

In 2011 the systems investigated included primarily 1) RNA and DNA, and 2) a peptide (small protein) which binds heavy metal ions, with a molecular design based on

known Hg^{2+} binding naturally occurring proteins of the so-called MerR family. The latter will be described in some detail in the following. The long term goal of this project is to optimize the design of the peptide to selectively bind for example $\text{Hg}(\text{II})$. Using bacteria to produce large amounts of the peptide, it may be possible to exploit the designed peptide in biotechnological purification of water. The $^{199\text{m}}\text{Hg}$ PAC experiments are complemented with a broad spectrum of other standard as well as highly specialized spectroscopic techniques (absorption of UV and visible light, NMR spectroscopy, determination of speciation at different pH, and synchrotron based circular dichroism spectroscopy). In combination these techniques demonstrate that the peptide binds $\text{Hg}(\text{II})$ very strongly with coordination of the two thiolate groups (cysteines) present in the amino acid sequence, and that $\text{Hg}(\text{II})$ therefore affects the folding of the peptide. In addition the data indicate that structural changes occur with changes of pH. Adding Cd^{2+} to the peptide results in different groups from the peptide coordinating to the metal ion, and even leads to the formation of metal ion bridged peptide- Cd^{2+} -peptide complexes at high pH. These differential binding modes of two metal ions imply that it may be possible to design the peptide to selectively and strongly bind $\text{Hg}(\text{II})$. From a different but equally important perspective, the results also illustrate that metal ions may be used to control the structure and aggregation state of peptides. This has potential implications for the role of metal ions in diseases where protein aggregation occurs, such as Alzheimer's disease. The

results of a similar study, where the PAC data were recorded at ISOLDE in 2010 on a larger designed protein was published recently [1], demonstrating that it is possible to design a so-called triple helix bundle protein which binds a metal ion in a particular coordination geometry.

Chakraborty S., Kravitz J.Y., Thulstrup P.W., Hemmingsen L., DeGrado W.F., and Pecoraro V.L. *Realization of a Designed Three-Helix Bundle Capable of Binding Heavy Metals in a Tris(Cysteine) Environment*

Angew. Chem. Int. Ed., 2011, 50: 2049-2053: The manuscript was selected for the inside cover of this issue of the journal, see figure designed by PeterW. Thulstrup from the PAC group in Copenhagen: <http://onlinelibrary.wiley.com/doi/10.1002/anie.201100297/abstract>

Lars Hemmingsen

IS498: A multi-reflection time-of-flight mass separator for isobaric purification at ISOLTRAP

Isobaric contaminations pose a severe challenge for experiments with short-lived nuclides. About two decades ago the scheme of quadrupolar excitation in the presence of a buffer gas has been invented at ISOLTRAP [Muk08] to isolate and prepare the ions of interest for precision mass measurements. However, this technique is applicable only if the number of contaminant ions does not exceed certain limits [Her10]. A promising approach to further suppress contaminations is the application of a multi-reflection time-of-flight mass separator (MR-ToF MS) [Pla08]. Thus, such a device has recently been built at the University of Greifswald [Wol10] and implemented into the ISOLTRAP setup.

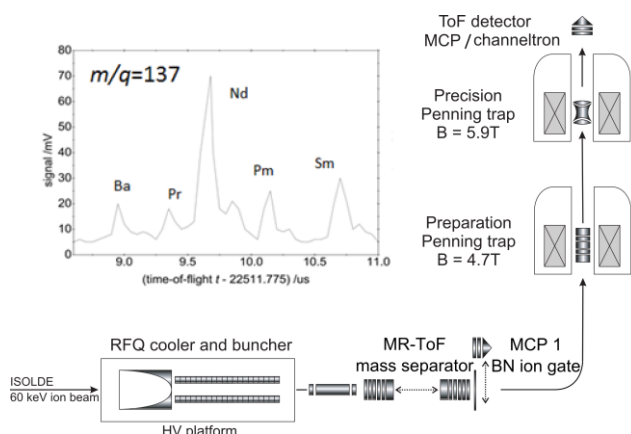

Fig. 1: ISOLTRAP setup with isobar spectrum (inset) of $A=137$ nuclides, as observed at the detector MCP 1.

Figure 1 shows an overview of the current ISOLTRAP setup, including the new section (on the right side at the bottom). The MR-ToF MS consists of two ion mirrors between which ion pulses with up to several keV kinetic energy can be stored. Thus, the device can be viewed as an electrostatic ion beam trap [Zaj97]. Essentially, the flight path of several kilometers is folded to the length of a table-top device and different species separate according to their masses. High mass-resolving powers of up to $R = m/\Delta m = t/2\Delta t_{FWHM} \approx 200,000$ with a transmission of about 50% have been achieved on milliseconds time ranges in recent off-line experiments after implementation at ISOLTRAP. To select the separated species, a Bradbury-Nielsen ion gate has been added behind the MR-ToF-MS with a transmission of about 95% for the ions of interest.

The combined suppression of contaminant ions by the MR-ToF MS and the preparation trap is expected to be 10^7 , enough to reach into areas of the chart of nuclides which have so far been difficult to access. This will allow one to achieve new mass data filling the current gaps on, e.g., proton and neutron separation energies and related numbers important for nuclear structure

calculations as well as the modeling of stellar nucleosynthesis. Mass separation with the new device has already been successfully applied on-line in the 2010 beam-time. As the inset of fig. 1 shows for the example of $A=137$, several isobaric species have been resolved. After its isolation the mass of ^{137}Eu could be determined for the first time although this ion species was heavily contaminated with ^{137}Ba , ^{137}Pr , ^{137}Nd , ^{137}Pm and ^{137}Sm .

- [Muk08] M. Mukherjee *et al.*, Eur. Phys. J. A **35**, 1 (2008)
- [Her10] A. Herlert *et al.*, Hyperfine Interact., accepted
- [Pla08] W. R. Plaß *et al.*, Nucl. Instr. Meth. Phys. Res. B **266**, 4560 (2008)
- [Wol10] R. N. Wolf *et al.*, Hyperfine Interact., accepted
- [Zaj97] D. Zajfman *et al.*, Phys. Rev. A **55**, R1577 (1997)

R. N. Wolf and L. Schweikhard for the ISOLTRAP collaboration

IS499: Study of the onset of deformation and shape coexistence in ^{46}Ar via the inverse kinematics (t,p) reaction

Currently there are many efforts to understand the evolution of nuclear structure of neutron-rich nuclei below the doubly magic ^{48}Ca nucleus. Experimental and theoretical studies suggest a continuous reduction of the classical $N=28$ neutron shell gap with decreasing proton number. Shell model calculations predict a weakening of the $N=28$ shell closure already in ^{46}Ar , placed only two neutrons below ^{48}Ca , resulting in a relatively large $B(E2)$ value [1]. New lifetime measurements of the 2^+_1 state in ^{46}Ar confirm these predictions [2], while intermediate Coulomb excitation experiments suggest a much

smaller value for the $2^+_1 \rightarrow 0^+_1$ E2 transition strength [3].

The aim of the IS499 experiment was to gain additional, complementary information on states in ^{46}Ar by a two neutron transfer reaction, in particular to identify the first excited 0^+ state. A candidate for this shape coexisting state has been identified at 2.7 MeV [4].

The experiment was successfully performed in October 2010. The ^{44}Ar with an average intensity of $5 \cdot 10^4$ /s beam was accelerated to 2.16 MeV/u using REX and guided onto a tritium-loaded Ti target at the center of the T-REX target chamber [5]. Light, target-like reaction products were detected and identified using the position sensitive ΔE -E Si detector telescopes of the T-REX array, while γ -rays were detected using the MINIBALL γ -spectrometer. The same technique was previously used to identify and characterize the 0^+ states in the "Island of Inversion" nucleus ^{32}Mg [6]. In addition to the $^{44}\text{Ar}(t,p)$ reaction, several hours of data with a deuterated target as well as data for the $^{44}\text{Ar}(t,d)$ reaction have been collected to gain additional information on the intermediate nucleus ^{45}Ar .

Transfer reactions involving a tritium target are currently only possible at reduced REX energies in order to avoid fusion reactions with the target carrier material Ti. Such fusion reactions would produce protons which cannot be distinguished from the transfer reaction products. In order to circumvent this limitation a fusion veto detector has been designed and constructed at the TU Munich. First tests with stable beams at ISOLDE show that this new device allows separating the fast beam-like particles from the slower, heavier fusion products.

A first analysis of the data at the TU Munich already indicates the population of several states in ^{46}Ar after the two-neutron transfer reaction. Figure 1 shows the energy of

protons identified in T-REX versus their laboratory scattering angles. The ground state and several excited states can be seen.

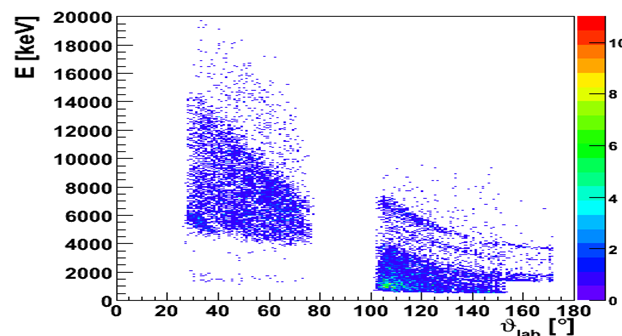

Figure 2: Proton energy versus laboratory scattering angle.

In the ongoing analysis proton angular distributions will be extracted and compared to DWBA calculations in order to determine the angular momentum transfer. Furthermore from the relative population of the states information on the neutron configurations can be obtained. From the results of this experiment one will possibly gain direct information on shape-coexisting phenomena and the vanishing $N=28$ shell closure in this interesting region below ^{48}Ca .

- [1] E. Caurier et al., Eur. Phys. J. A 15, 145 (2002).
- [2] D. Mengoni et al., Phys. Rev. C 82, 024308 (2010).
- [3] A. Gade et al., Phys. Rev. C 71, 051301(R) (2005).
- [4] Z. Dombrádi et al., Nucl. Phys. A 727, 195 (2003).
- [5] V. Bildstein et al., Prog. Part. Nucl. Phys. 59, 386 (2007).
- [6] K. Wimmer et al, Phys. Rev. Lett. 105, 252501 (2010).

D.Mücher, K. Nowak, K. Wimmer

Target and Ion Source Development:

The target and ion source development program has made good progress this year and new young members will soon join the team. The past year at ISOLDE has seen some very nice results, with the production of neutron rich Au isotope beams with an uranium carbide target and RILIS, after a first unsuccessful trial in 2008. Another highlight came with the first direct production at ISOLDE of Fe beams, more particularly that of ^{52g}Fe and ^{59}Fe by the combination of the nanostructured Y_2O_3 target developed by Sandrina Fernandes and the VADIS ion source. The same unit improved the ^{48}Cr delivered at ISOLDE by a factor of 250. It is worth mentioning here that Sandrina was awarded, for her contribution to the understanding of ISOL target materials, the prize of the European Material Research Society for young scientists, and has now taken a new position at MSU to develop the FRIB facility. On the front of specific reaction channels, we have also witnessed the application of the neutron converter for ^{27}Mg isotope production from SiC targets by (n, α) reactions. An overview of these different highlights (and some others not introduced here) is shown on Figure 1.

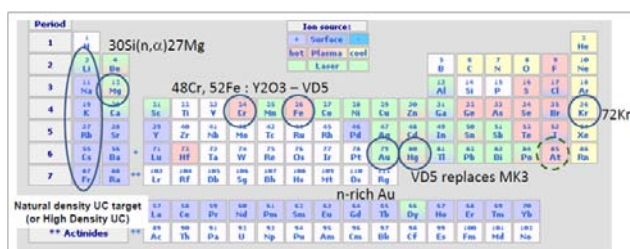

Figure 1: Overview of the new developments at ISOLDE in 2010.

In the following, we describe some of the ongoing activities related to the development of cold plasma sources for molecular ions.

Increased ionization efficiencies for light noble gases and for molecules are still required for approved physics experiments, such as IS445, and for future installations such as HIE-ISOLDE (Letters of Intent I-118, I-119) and EURISOL. Currently used ion sources (mainly laser (RILIS) and arc discharge –type ion sources (FEBIAD and VADIS) do not efficiently ionize light noble gases, such as helium, and molecules such as CO , CO_2 , N_2 and NO . In order to improve the intensity of these beams, two new plasma ion sources are integrated in the ISOLDE target and ion source base. This will complement the Minimono ECR ion source in the portfolio of the cold plasma ion sources.

Q-COMIC (Figure 2)

The new COmpact MICrowave and Coaxial (COMIC) ion source designed by P. Sortais et al. at LPSC/Grenoble uses 2.45 GHz microwave power to generate plasmas. A special version of the source was developed for ISOLDE where it incorporates a plasma chamber fully made of quartz, which we define as the Q-COMIC. This should provide chemically favorable conditions for molecular ion beam production, especially for CO_2 . The beam current stability is typically better than 1 % and beams are easily reproducible on the offline separator. The highest efficiency achieved so far for xenon is about 15 %. However, the main goal is to produce molecular beam including radioactive carbon (as CO^+ or CO_2^+), in which case the efficiency was measured to be about 0.2 %. Several directions for the improvement of these results are under investigation.

HELICON (Figure 3)

This second plasma ion source project develops radiation hard Helicon-type ion source operating in the frequency range of 20 ... 200 MHz, notably smaller than the ECR-type 1+ ion sources. The first plasma ignition tests have been performed and different antenna geometries have been tested. The preliminary efficiency figure measured for CO_2^+ of 1 % has been obtained, and further tests are planned to confirm and eventually improve these encouraging results. The electron energy distribution and density in the Helicon plasma is high enough to break the CO_2 molecules, resulting in the deposition of some carbon atoms on the chamber walls. Due to the recycling from plasma to the walls and vice-versa, it is now necessary to develop a new pulsed gas injection system in order to study the time-scales of these processes.

Going OnLine...

The new Front-End 7, just installed in the GPS target area is equipped with a new coaxial coupling system. The new system is radiation hard and enables remote handling of the units with coaxial RF systems up to 2.5 GHz and 200 W. This system will be used beyond the strict domain of plasma ion sources, since it is foreseen to for instance supply the Laser Ion Source and Trap (LIST) with the required RF current.

Both COMIC and HELICON sources will be benchmarked at the offline separator during spring 2011; the best performing source will be prepared with fully radiation hard components during the summer of 2011 and first online tests are foreseen towards the end of 2011.

References:

S. Fernandes et al., J. Nucl. Mat., in press.

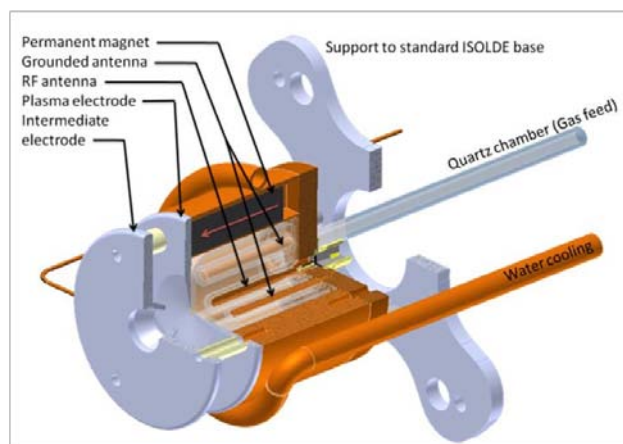

Figure 2: Cross-section view of the Q-COMIC ion source design

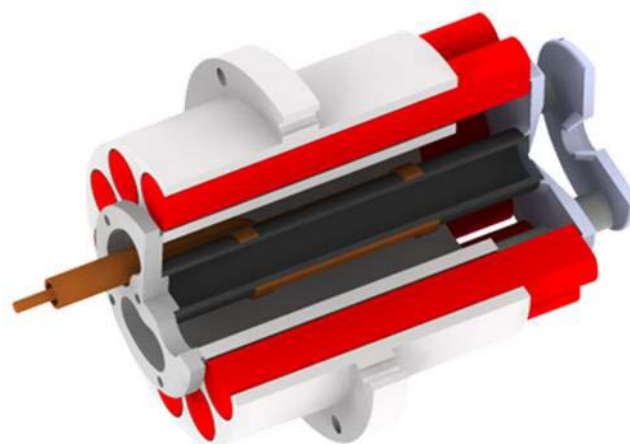

Figure 3: Cross-section view of the Helicon ion source design

P. Suominen, T. Stora

Project for a Storage-ring facility at HIE-ISOLDE:

Stored secondary beams enable a wide range of nuclear physics experiments as has been proven in experiments over the last two decades at the cooler-storage ring ESR in Darmstadt and since very recently also at the CSRe ring in Lanzhou [1,2]. These facilities, however, are specialized on experiments at relativistic energies. Efforts

are presently undertaken to employ the existing storage rings also for nuclear physics experiments at lower energies, which inevitably requires the still inefficient and time consuming slowing down of stored ion beams. Therefore it is of interest to explore the possibility of installing a storage ring at an ISOL facility which naturally delivers low emittance low energy beams.

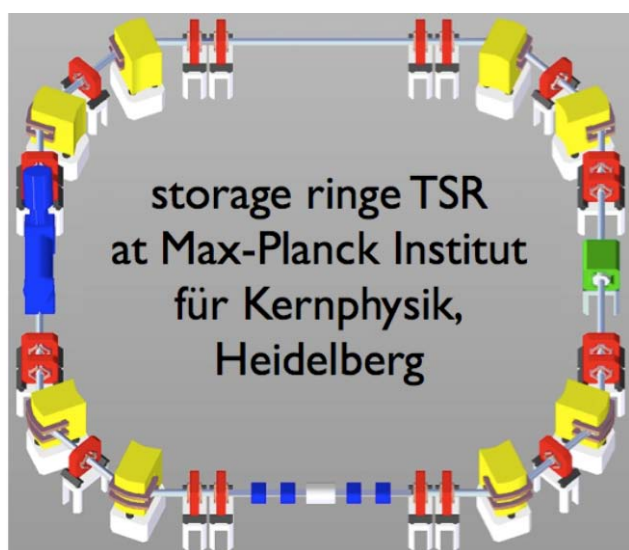

It is suggested to move the existing heavy-ion storage ring TSR to HIE-ISOLDE. The heavy-ion storage ring TSR is in operation at MPIK since 1988. The circumference of the TSR is 55.4 m and its maximal magnetic rigidity is 1.5 Tm. Each of the four symmetric focusing periods consists of two 45° dipole magnets, five quadrupole magnets and three sextupole magnets. A schematic view of the TSR ring is shown in the figure. The TSR has four 5.2 m long straight sections which offer ideal conditions for setting up different experiments. The electron cooler allows achieving stored beams with extremely small horizontal and vertical emittances. A dedicated ultra-cold electron target has been developed in the TSR for high-resolution experiments with electrons. Also the laser cooling can be applied to a selected number of heavy ion species. The TSR has an RF resonator which

can be used to accelerate or decelerate stored beams. A peculiar property of the TSR is a high momentum acceptance of about $\pm 3\%$, which may be used for storing exotic ions in several charge states or different radioactive nuclides with similar mass-over-charge ratios. An overview of stored beam intensities and beam lifetimes achieved in the TSR can be found on the TSR web-page [4].

New physics ideas for possible in-ring experiments at HIE-ISOLDE have been suggested in the LOI. In the following we briefly sketch them:

- Experimental information on capture reactions (p,γ) and (α,γ) is very scarce and is so far restricted to stable isotopes. The stored beam is intersected by an internal gas-jet target and the recoils are measured with high efficiency after a bending magnet. The high beam intensities achieved by accumulation in the TSR will allow moving away from the stability reaching vp - and later rp -process nuclei.
- One- and two-nucleon transfer reactions, due to their selectivity, provide unique information on nuclear structure. The secondary beams from HIE-ISOLDE can be efficiently stored and cooled in the TSR. The low gas-jet target thickness is compensated by the recirculation and accumulation of ions. Owing to the excellent beam energy definition and the absence of straggling in the target, a superior energy resolution is expected.
- Atomic charge states can dramatically modify nuclear decay constants. Investigations of nuclear half-lives as a function of atomic charge states and of spin-parities for the parent and daughter nuclei are proposed. Such experiments can be used, for instance, to address the electron screening in beta decay.
- It is predicted that 20-30% of ${}^7\text{Be}$ in the core of the Sun is present as hydrogen-

like ions. However, the half-life of hydrogen-like ${}^7\text{Be}$ could not be measured up to now, which will be feasible at TSR@ISOLDE.

- Nuclear isomeric states are important probes to explore nuclear structure. Owing to the sensitivity to single stored ions, the storage-ring mass spectrometry is a unique tool to study such long-lived rare nuclear species.
- Di-electronic recombination (DR) is a well-established atomic physics research program at the TSR and the ESR. A broad scientific program can be pursued at ISOLDE, where isotopic or/and isotonic shifts can be measured thus providing information on nuclear charge radii. Furthermore, using resonant character of DR, purification of beams in ground or alternatively isomeric states is feasible, in principle. Experiments with such purified beams may be suitable for studies on laser interaction with the nuclei or for the search of predicted Nuclear Excitation by Electron Capture (NEEC) phenomenon.
- Beta beams are today one of the possible long baseline facilities to explore neutrino properties, primarily neutrino oscillation physics including CP violation in the leptonic sector. The (anti-)neutrinos are produced by acceleration and final storage of beta-decaying isotopes. The TSR@ISOLDE can be used as a versatile tool to investigate different technical aspects. One of the key studies before a full-scale experiment is envisaged is the efficient production and storage of ${}^6\text{He}/{}^{18}\text{Ne}$ or ${}^8\text{Li}/{}^8\text{B}$ ion beams.
- Last, but not least, the high resolution of storage rings may be employed for cleaning the ion beam from isobaric contaminants.

The realization of the proposed project requires several improvements of the present REX- ISOLDE facility. These improvements include an upgrade of the

present REX-EBIS to a Super-EBIT. Moreover, the TSR ring needs about $20\text{ m} \times 20\text{ m}$ area for installation, which inevitably requires an extension of the ISOLDE experimental hall. Technical aspects of the realization of the project are being presently worked out in detail by the collaboration.

[1] B. Franzke, H. Geissel & G. Münzenberg, *Mass Spectrometry Reviews* 27 (2008) 428

[2] Yu.A. Litvinov & F. Bosch, *Rep. Prog. Phys.* 74 (2011) 016301

[3] A. Andreyev et al., "Storage ring facility at HIE-ISOLDE", LOI to INTC, 2011.

[4] Ion Storage Ring TSR, <http://www.mpi-hd.mpg.de/blaum/storage-rings/tsr/index.en.html>

K. Blaum, Y.A. Litvinov



How to obtain access to the ISOLDE hall

1. Register at the CERN Users office¹. You need to bring
 - a. [Registration form](#) signed by your **team leader or deputy**²
 - b. Proof of attachment³ to Institute or University **in English or French**
 - c. Passport
 - d. Copy of medical insurance (for illness, private accidents, and work accidents and disability arising from such accidents at CERN)

2. Get your CERN access card in [Building 55](#)

With this registration procedure you become a **CERN user**⁴.

3. Follow the CERN basic safety course (levels 1 to 3):
 - a. If you have a CERN account, you can access the Safety Awareness course on-line at the web page <http://sir.cern.ch>, from your computer, inside or outside CERN.
 - b. If you have not activated your CERN account, there are some computers available for use without the need to log in on the first floor of building 55 (Your CERN badge will be needed in order to prove your identity).
4. Follow the radiation protection course only if you need to get a permanent personal dosimeter⁵. Please make a reservation for the course via EDH

- (CERN Electronic Document Handling) well in advance of your arrival at CERN⁶.
5. Obtain a radiation dosimeter at the Dosimetry service, located in [Building 55](#)⁷. Two options exist:
 - a. Temporary dosimeter. Issued only once per calendar year for a maximum of 2 months.
 - b. Permanent dosimeter. A [medical certificate](#)⁸, valid for 24 months, is required. The permanent dosimeter needs to be readout monthly⁹.
6. Apply for access to ISOLDE hall using EDH: <https://edh.cern.ch/Document/ACRO>. This can be done by any member of your collaboration (typically the contact person) having an EDH account¹⁰.

Find more details at the [information about registration for Users](#) page.

New users are also requested to visit the ISOLDE User Support office while at CERN.

Opening hours:

Mon., Tues., Thurs., Fri. 08:30-12:30

Mon. & Thurs. 13:30-15:30

¹ <http://cern.ch/ph-dep-UsersOffice> ([Building 61](#), open 8:30-12:30 and 14:00-16:00, closed Wednesday morning).

² Make sure that the registration form is signed by your team leader before coming to CERN or that it can be signed by the team leader or deputy upon arrival.

³ Proof of attachment to Institute or University should not be signed by the person nominated as your team leader.

⁴ The first registration as USER needs to be done personally, so please note the opening hours. If needed the extension of the registration can be delegated or performed on-line via EDH.

⁵ The radiation protection course is mandatory to obtain a permanent personal dosimeter.

⁶ If it is not possible to sign up for a course, a temporary dosimeter can be issued for the first registration at CERN.

⁷ <http://cern.ch/service-rp-dosimetry> (open *only in the mornings* 08:30 - 12:00).

⁸ The medical certificate must be brought in person to the Dosimetry Service (either by the user or a representative)

⁹ There are reader stations at the ISOLDE hall and the CERN main building. You can leave your *permanent dosimeter* in the rack outside the ISOLDE User Support office.

¹⁰ Eventually you can contact Jenny or the Physics coordinator.

Contact information

ISOLDE User Support

Jenny Weterings

Jennifer.Weterings@cern.ch

+41 22 767 5828

Chair of the ISCC

Maria Jose G^a Borge

borge@iem.cfmac.csic.es

+34 91 59 01 614

Chair of the INTC

Peter Butler

peter.butler@liverpool.ac.uk

+44 151 794 3443

ISOLDE Physics Section Leader

Yorick Blumenfeld

Yorick.Blumenfeld@cern.ch

+41 22 767 5825

ISOLDE Physics Coordinator

Magdalena Kowalska

Magdalena.Kowalska@cern.ch

+41 22 767 3809

ISOLDE Technical Coordinator

Richard Catherall

Richard.Catherall@cern.ch

+41 22 767 1741

HIE-ISOLDE Project Leader

Yacine Kadi

Yacine.Kadi@cern.ch

+41 22 767 9569

More contact information at

<https://isolde.web.cern.ch/ISOLDE/default2.php?index=index/groupindex.htm&main=group/contacts.php> and at

<https://isolde.web.cern.ch/ISOLDE/default2.php?index=index/groupindex.htm&main=group/places.php>

